

ZX-8.3J

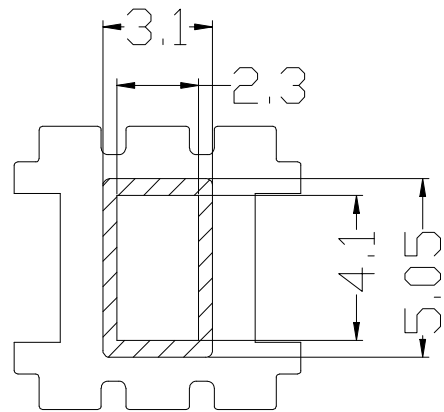

SEC A-A

REV.	REVISIONS REC.		DATE	REV.	REVISIONS REC.		DATE
1				4			
2				5			
3				6			
DRAWN & DRAFTED BY		LIU WEI QIANG	TOLERANCES		ANGLE:	TITLE:	
CHECKED & APPROVED BY		ZHANG YONG	0<L≤4 ±0.1	pin pitch	±1°	EE-8.3(3+3P)	
			4<L≤16 ±0.2	±0.2	UNIT:	BOBBIN MATERIAL:	UL REC.
			16<L≤63 ±0.3		MM	PHENOLIC	UL 94V-0
					SCALE:	PIN MATERIAL:	PIN TENSION LOAD:
						CP WIRE	0.8KG MIN
					DATE:	DRAWING NO.	REV.
					2009.05.06	ZX-8.3J	A01

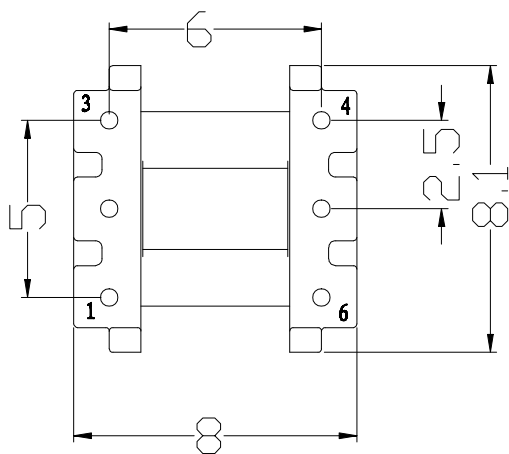
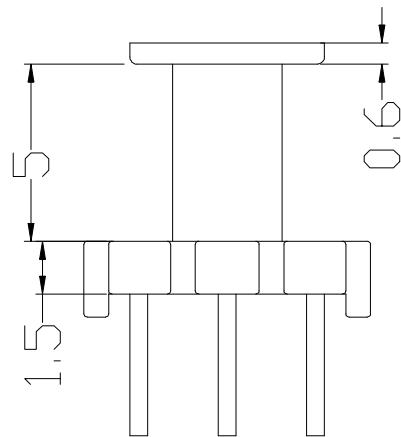
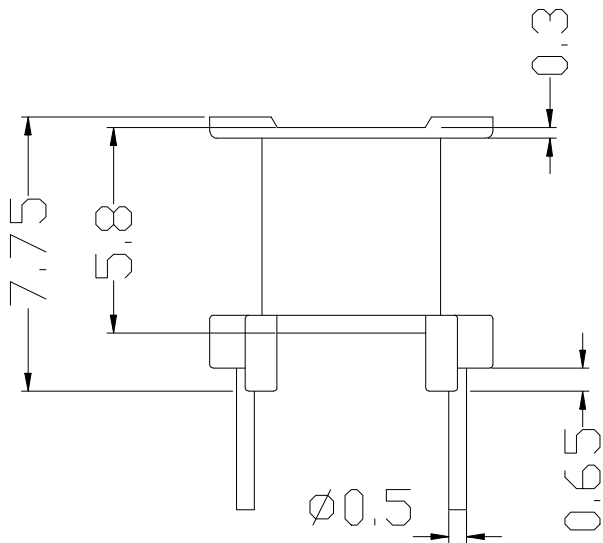
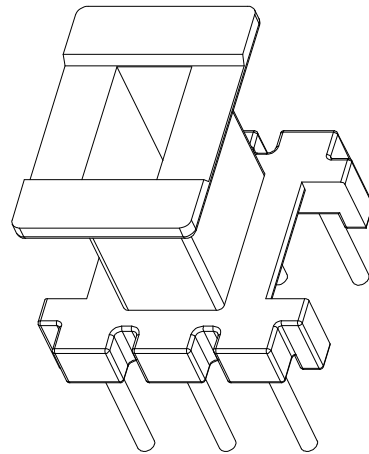
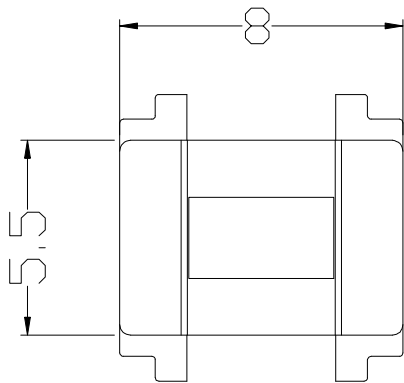

智信电子塑胶有限公司

ZHI XIN ELECTRONICS PLASTIC CO., LTD.
TEL:0769-86389901-2 FAX:0769-86389903

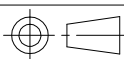

DATE: 2009.05.06

DRAWING NO. ZX-8.3J

REV. A01