

ZX-3A

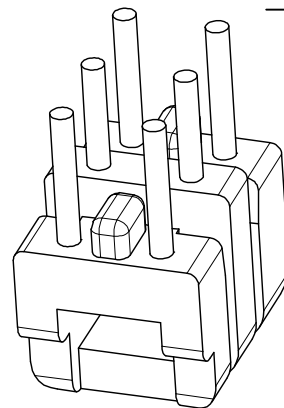

| REV. | REVISIONS | REC. | DATE | REV. | REVISIONS | REC. | DATE |
|-----------------------|-----------|---------------|------|------------------|-----------|-----------------------------|------|
| 1 | | | | 4 | | | |
| 2 | | | | 5 | | | |
| 3 | | | | 6 | | | |
| DRAWN & DRAFTED BY | | LIU WEI QIANG | | TOLERANCES | | ANGLE: $\pm 1^\circ$ | |
| CHECKED & APPROVED BY | | LIN JUN | | 0 < L ≤ 4 ±0.1 | | pin pitch | |
| | | | | 4 < L ≤ 16 ±0.2 | | UNIT: MM | |
| | | | | 16 < L ≤ 63 ±0.3 | | BOBBIN MATERIAL: PHENOLIC | |
| | | | | | | UL REC. UL 94V-0 | |
| | | | | | | PIN MATERIAL: CP WIRE | |
| | | | | | | PIN TENSION LOAD: 0.8KG MIN | |
| | | | | SCALE: | | DATE: 2013.01.22 | |
| | | | | | | DRAWING NO. ZX-3A | |
| | | | | | | REV. A01 | |

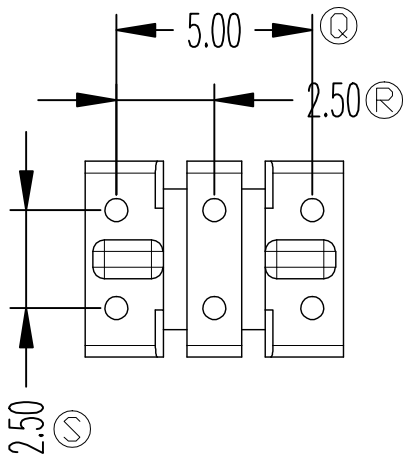
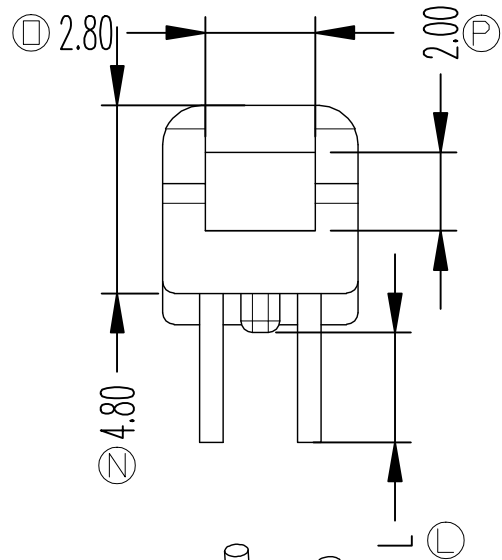
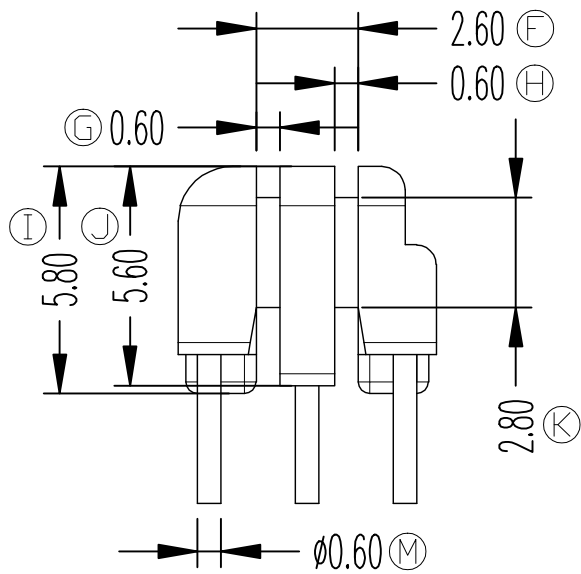
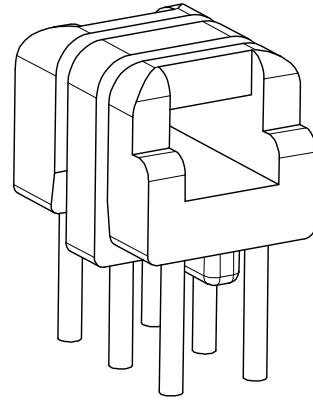
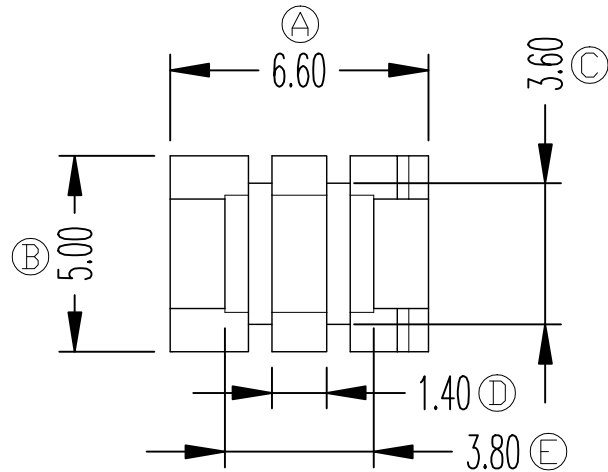

智信电子塑胶有限公司
ZHI XIN ELECTRONICS PLASTIC CO., LTD.
 TEL: 0769-86389901-2 FAX: 0769-86389903

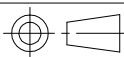

DATE: 2013.01.22

DRAWING NO. ZX-3A

REV. A01