

ZX-22U

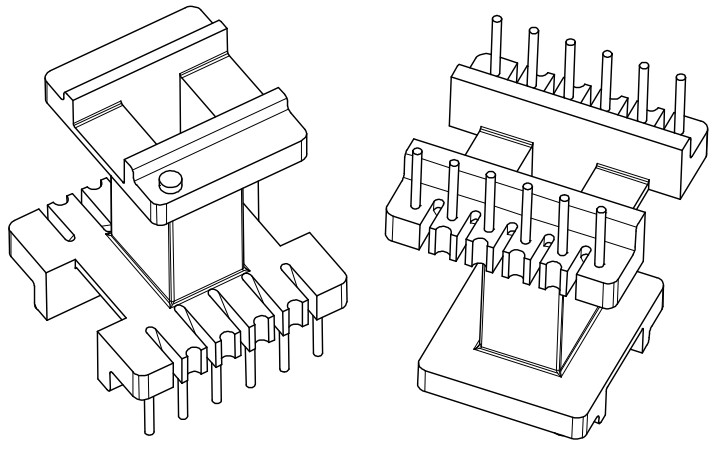

REV.	REVISIONS	REC.	DATE	REV.	REVISIONS	REC.	DATE
1				4			
2				5			
3				6			
DRAWN & DRAFTED BY		LIU WEI QIANG		TOLERANCES		ANGLE: $\pm 1^\circ$	
CHECKED & APPROVED BY		ZHANG YONG		$0 < L \leq 4 \pm 0.1$ $4 < L \leq 16 \pm 0.2$ $16 < L \leq 63 \pm 0.3$		pin pitch $\pm 0.2$ TITLE: EE-22(6+6P)	
SCALE: MM				BOBBIN MATERIAL: PM-9820		UL REC. UL 94V-0	
DATE: 2019.07.15				PIN MATERIAL: CP WIRE		PIN TENSION LOAD: 1.2KG MIN	
DRAWING NO. ZX-22U				REV. A01			

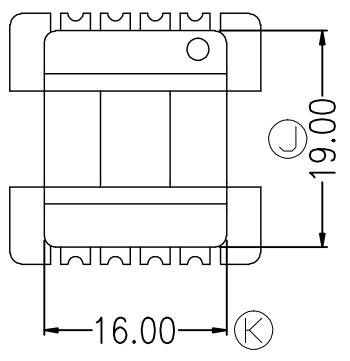
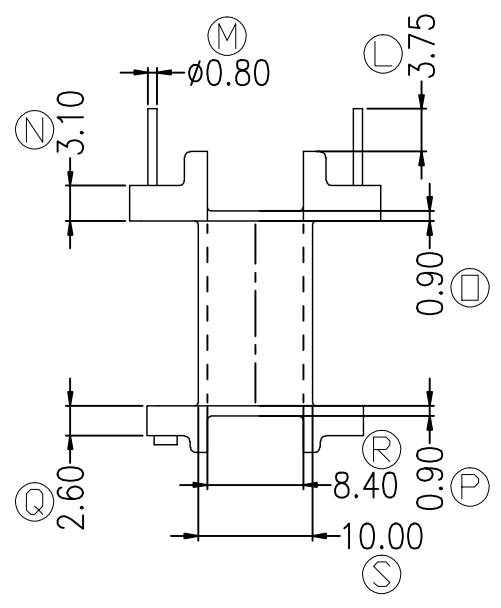
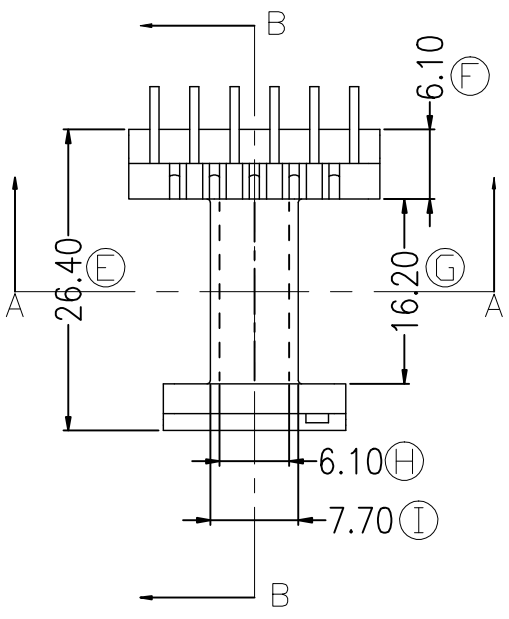
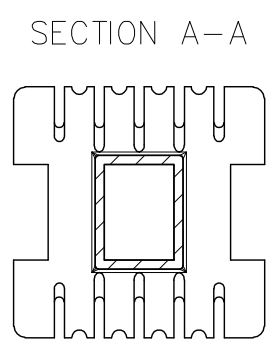
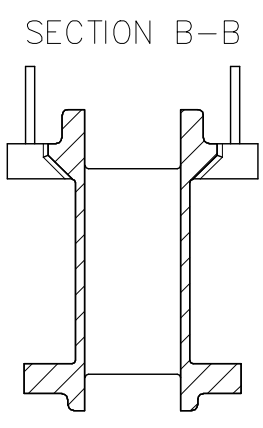
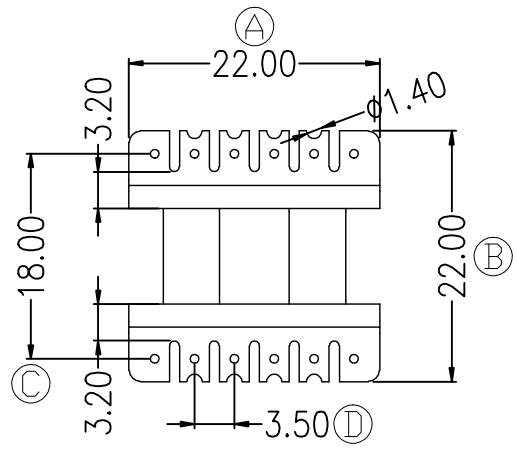

**智信电子塑胶有限公司**  
 ZHI XIN ELECTRONICS PLASTIC CO., LTD.  
 TEL: 0769-86389901-2 FAX: 0769-86389903