

ZXS-15F1

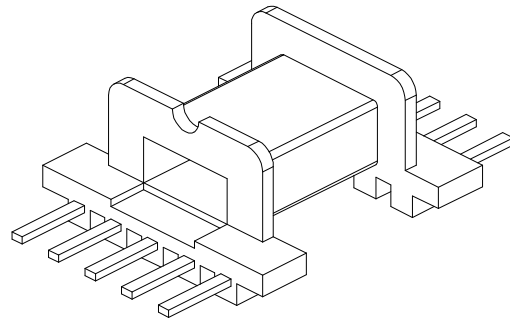
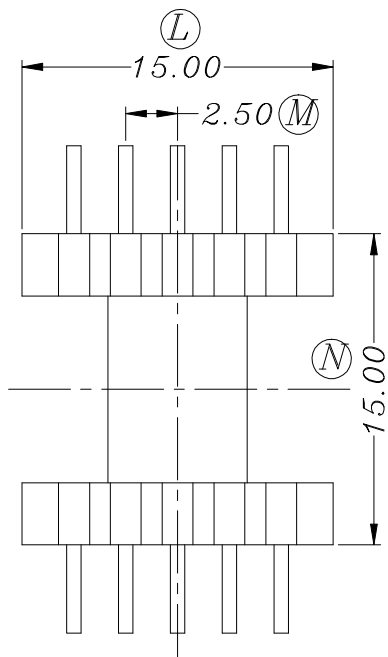
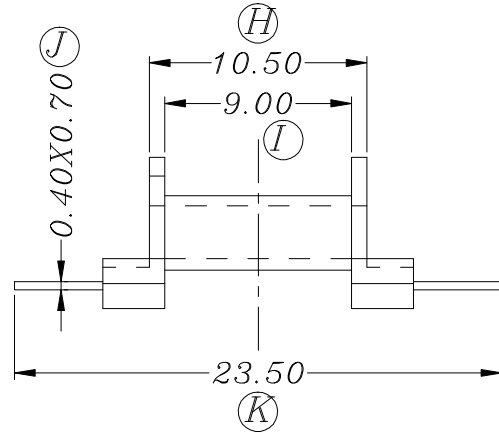
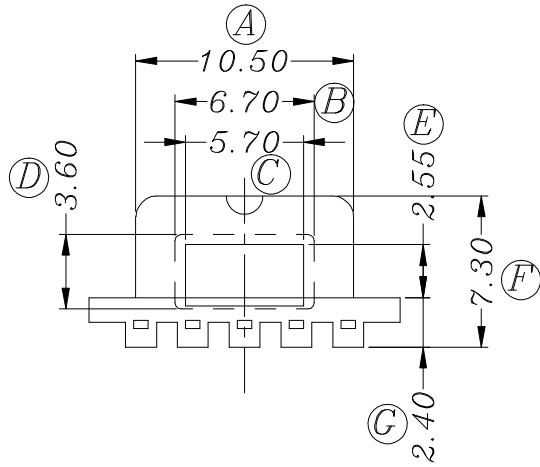

REV.	REVISIONS REC.		DATE	REV.	REVISIONS REC.		DATE
1				4			
2				5			
3				6			
DRAWN & DRAFTED BY	LIU WEI QIANG	TOLERANCES		ANGLE:	TITLE: EFD-15(5+5P)		
CHECKED & APPROVED BY	MA BU JIAN	0<L≤4 ±0.1	pin pitch ±0.2	UNIT:	BOBBIN MATERIAL:	UL REC. UL 94V-0	
		4<L≤16 ±0.2		MM	PIN MATERIAL:	CP WIRE	
		16<L≤63 ±0.3		SCALE:	PIN TENSION LOAD:	0.8KG MIN.	
智信电子塑胶有限公司 ZHI XIN ELECTRONICS PLASTIC CO., LTD. TEL:0769-86389901-2 FAX:0769-86389903				DATE: 2006.04.14	DRAWING NO.	ZXS-15F1	REV. A01