

# ZX-B015

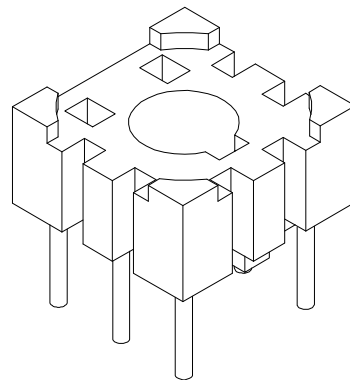

REV.	REVISIONS	REC.	DATE	REV.	REVISIONS	REC.	DATE		
1				4					
2				5					
3				6					
DRAWN & DRAFTED BY		LIU WEI QIANG		TOLERANCES		ANGLE: $\pm 1^\circ$		TITLE: BASE(3+3P)	
CHECKED & APPROVED BY		MA BU JIAN		$0 < L \leq 4 \pm 0.1$ $4 < L \leq 16 \pm 0.2$ $16 < L \leq 63 \pm 0.3$		pin pitch $\pm 0.2$		UNIT: MM	
				SCALE:		PIN MATERIAL: CP WIRE		BOBBIN MATERIAL: PHENOLIC	
						DATE: 2008.08.26		UL REC. UL 94V-0	
						DRAWING NO. ZX-B015		PIN TENSION LOAD: 1.2KG MIN	
								REV. A01	

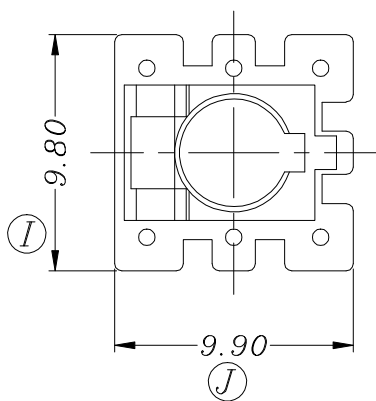
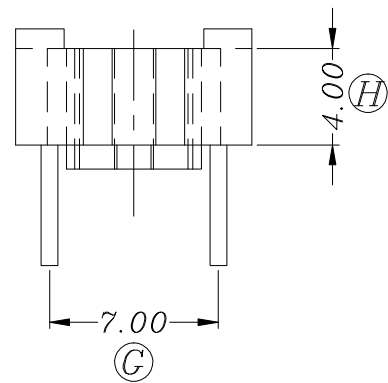
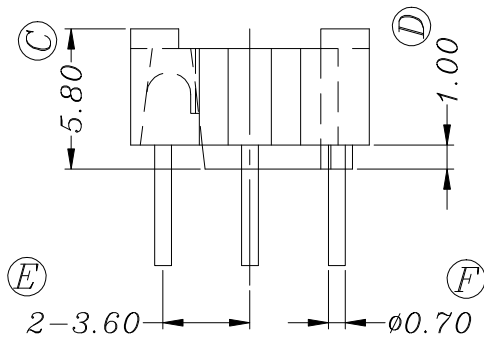
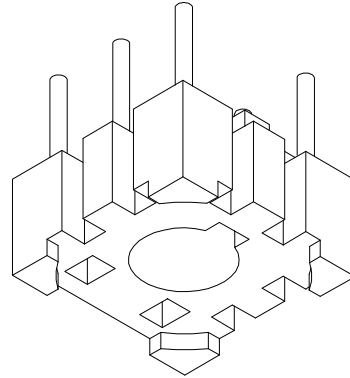
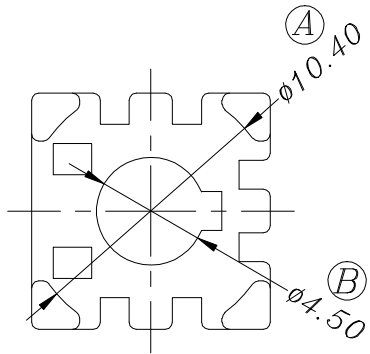

**智信电子塑胶有限公司**  
**ZHI XIN ELECTRONICS PLASTIC CO., LTD.**  
 TEL: 0769-86389901-2 FAX: 0769-86389903

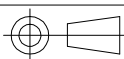

DATE: 2008.08.26

DRAWING NO. ZX-B015

REV. A01